

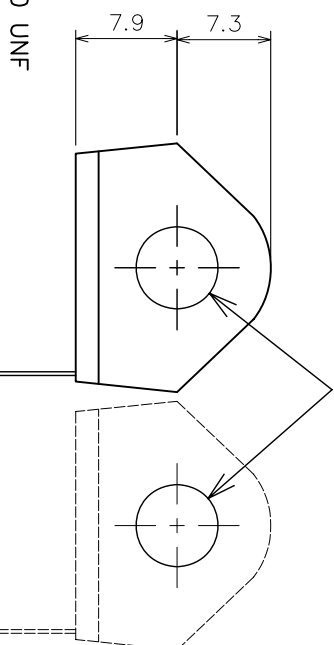

ISOMETRIC VIEW

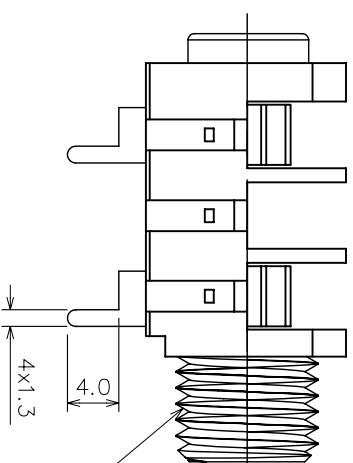
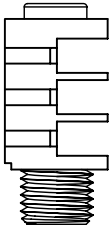

MATERIAL PROPERTIES

Parts	Description	Material	Remark
	Jack Body	Polyamide	Black
	FIBRE WASHER (1.6mm Th.)	Vulcanized Fibre	Black
	Plastic Nut	Polyamide	Black
	Metal Contact	Nickel Silver	Tin Plated

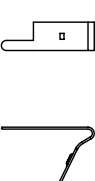
SUPPLY NUTS AND WASHERS AS LOOSE PARTS

DIMENSIONS IN MILLIMETERS  
3rd ANGLE PROJECTION  
SCALE: N.T.S.

ISSUE	AMEND	DATE	CHECKED PCS	FINISH: AS MOULDED
1	1st DRAWN	08/07/14		

DRAWN PYQ MATERIAL: AS TABLE

TOLERANCES  
NO DECIMAL PLACE ± 1.0  
1 DECIMAL PLACE ± 0.5  
2 DECIMAL PLACES ± 0.1  
DIAMETER HOLES ± 0.1  
ANGLES ± 1/2 DEGREE  
(UNLESS OTHERWISE STATED)

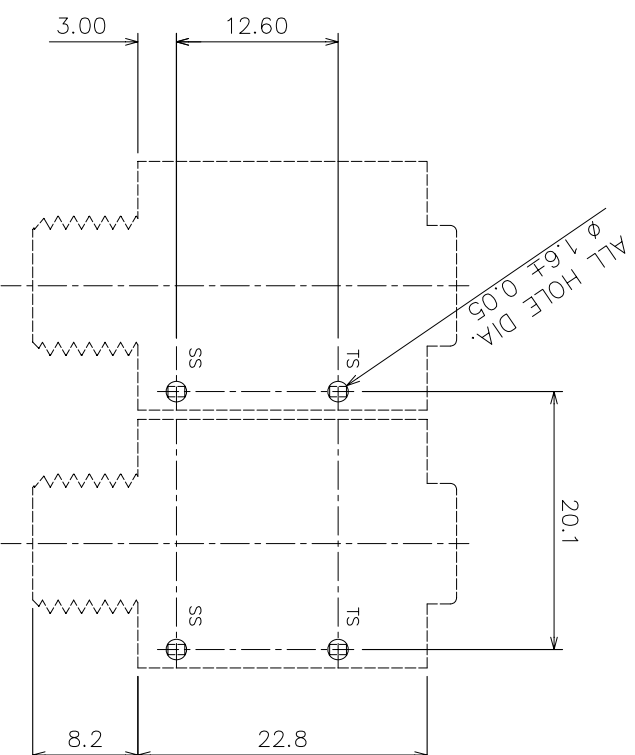

PCB LAYOUT



CHK

TITLE: 6.35 PHONE JACK, PC-A/SNS  
DRWG NO: JA-2040

